

Model No.: **P4PSMXYY-FR**  
 Description: **Ø22.5 Plastic Clip on Series non illuminated Mushroom pushbutton, Momentary**



### Salient Features:

- Compact design
- Quick installation
- Safe operation
- Robust design
- Aesthetically elegant
- Available in variety of colors
- IP65 protection
- All plastic raw material f1 UV stabilized as per UL746C
- HL3-R26 as per BS EN 45545-2

### General Characteristics:

It consists of one non illuminated mushroom actuator with Clip on Plastic bracket (P4BRK) fitted to it with contact elements of FMR C... series. Refer Datasheet for FMR C1 element & Datasheet for FMR C2 element. The actuator has IP65 as degree of protection as per IEC 60529. A minimum of one contact element & a maximum of six clip on contact elements can be stacked on the bracket of this actuator by a simple push action.

This unit can be used with any panel, ranging from 1mm to 6mm thickness. The actuator can be fastened to the panel with the lock ring provided. Fixing flange can be easily assembled to the actuator without any additional hardware by a simple push action. To release the bracket from the actuator, insert a screwdriver in the groove provided on the bracket. With a twisting movement of screw driver, the bracket separates out from the actuator

Available types	: <b>P4PSMXYY-FR</b> <b>X</b> indicates color color=1-White,2-Black, 3-Green, 4-Red,5-Amber, 6-Blue, 7-Clear 8-Yellow <b>YY</b> indicates number of NO & NC contact elements <b>FR</b> indicates Fire Retardant V0 grade
Degree of protection	: IP65 as per IEC 60529
Degree of Pollution	: 3
Applicable standards	: UL508 IEC 60947-5-1 & 60947-5-5 CSA 22.2
Product Certification	:
	: Contacts:

### Mechanical Characteristics:

Function indicator		: NA
Terminal Capacity		: Maximum 2X1.5mm <sup>2</sup> or 1X 2.5mm <sup>2</sup> : Minimum 1X0.5mm <sup>2</sup>
Terminal marking		: 1NC 2 & 3NO 4 : Customized markings on stickers available on request
Terminal Torque	Nm	: 0.8 Screw head compatible with Posidrive or Phillips screw driver
Contact material		: Brass, Silver plated : Brass terminal, Silver rivet gold plated (Low Voltage application)
Operation		: Slow break (NO/NC)
Operating torque	Nm	: NA
Operating force	N	: 10
Positive operation		: NA
Conforming to IEC/EN 60947-5-1 Appendix K		
Operating travel	mm	: 5
Mechanical life		: over 1 million operations
Ambient	°C	: -25 to +70
Storage	°C	: -25 to +40
Overall Dimensions with sketch (LXBXH)	mm	: 74XØ40
Vibration resistance	Hz	: Frequency 10Hz to 500Hz, Acceleration: 100m/s <sup>2</sup> , Amplitude: 0.75mm, Sweep: 1 octave/min
Conforming to IEC 60068-2-6		
Shock resistance		: Half sine wave, Acceleration: 300m/s <sup>2</sup> , Pulse: 11ms, 3 shock per axis, 12 shocks
Conforming to IEC 60068-2-27		
Viewing Angle	°	: NA
Optical Axial intensity	mcd	: NA
Weight	gms	: Actuator: 65 : Pushbutton: 65 +10 for every single element

### Electrical Characteristics of contacts:

#### Make & Break Capacity

: AC15: 415VAC, 4A as per IEC 60947-5-1  
 : DC13: 110VDC, 1A as per IEC 60947-5-1

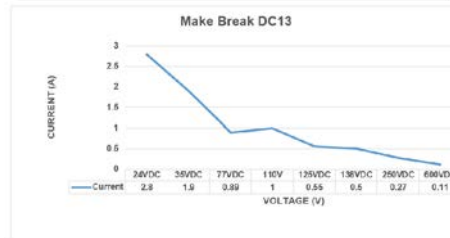
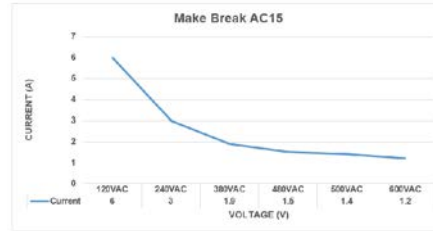

: A600, Q600 (Upto 600V AC/DC)  
 As per CSA C22.2 no. 14-10, UL 508

A500	IEC	120V, 6A	240V, 3A	380V, 1.9A	480V, 1.5A	500V, 1.4A	600V, 1.2A
Q600	IEC	125V, 0.55A	250V, 0.27A	400V, 0.15A	-	500V, 0.13	600V, 0.1A

A500	UL CSA	120V, 6A	240V, 3A	-	480V, 1.5A	-	600V, 1.2A
Q600	UL CSA	125V, 0.55A	250V, 0.27A	400V, 0.1A	480V, 0.1A	500V, 0.1A	600V, 0.1A

Electrical rating (for 1 million operation cycles at 3600 cycles per hour, load factor 0.5)

AC15		
V	24	120 230
A	4	3 2
DC13		
V	24	110
A	0.5	0.2

Rated insulation voltage

V : 500

Rated thermal current

A : 10

Low power application

: Gold plated NO & NC contact elements for low voltage low current switching circuits , <25mA  
 Models: C1, C2 (cover mounting), C7 & C8 (Base mounting)  
 (NO) (NC) (NO) (NC)

Short circuit protection

: 10A HRC cartridge fuse, rated for resistive loading at 1000A prospective current

Dielectric Test

KV : 2.5

Approvals regarding the part:

:   
 : Contact  

Approvals regarding the material

Polymeric parts

: UL-Recognized material

Rated Impulse Withstand

: NA

Polarity protection

: NA

Current Consumption

mA : NA

Electrical Endurance

: Conforming to IEC/EN 60947-5-1 Annexure C

### Accessories & codes:

NA

### Ordering codes

The ordering code for each product is mentioned in the Catalogue/Data Sheet and not indicated on each product because of the various combinations possible it becomes practically impossible to do so, more over the actuators, lamp unit and contact element, which together make a push button, are sold separately to OEM's as well as dealers. However the primary packing box always mentions the ordering code of the material it holds.

#### For actuator (with bracket):

<b>P4A</b> ↓ Plastic Clip on Series Actuator	<b>M</b> ↓ Mushroom	<b>X</b> ↓ Indicates color 1-White, 2-Black, 3-Green, 4-Red, 5-Amber, 6-Blue, 7-Clear 8-Yellow	<b>-FR</b> ↓ Fire Retardant
--	---------------------------	--	-----------------------------------

#### For actuator (without bracket):

<b>P4A</b> ↓ Plastic Clip on Series Actuator	<b>M</b> ↓ Mushroom	<b>X</b> ↓ Indicates color 1-White, 2-Black, 3-Green, 4-Red, 5-Amber, 6-Blue, 7-Clear 8-Yellow	<b>-FR</b> ↓ Fire Retardant	<b>NB</b> ↓ No Bracket
--	---------------------------	--	-----------------------------------	------------------------------

#### For Pushbutton

<b>P4PS</b> ↓ Plastic Clip on Series Pushbutton Switch	<b>M</b> ↓ Mushroom	<b>X</b> ↓ Indicates color 1-White, 2-Black, 3-Green, 4-Red, 5-Amber, 6-Blue, 7-Clear 8-Yellow	<b>YY</b> ↓ Denotes No. of Contact Elements attached to the Push Button.  1st "Y" indicates no. of. (NO) Contact elements  2nd "Y" indicates no. of (NC) Contact elements  e.g. 01 indicates No of NO (Normally Open) Contacts & one NC (Normally Closed) contact	<b>-FR</b> ↓ Fire Retardant
--	---------------------------	--	---	-----------------------------------

### Mounting Instructions:

Safety regulations: This unit may be installed & commissioned by personnel who are familiar with current regulation for health & safety at work & accident prevention. Ensure local regulations are met especially those relating to safety. This is for use on flat surface of type 4X, 12 enclosure.

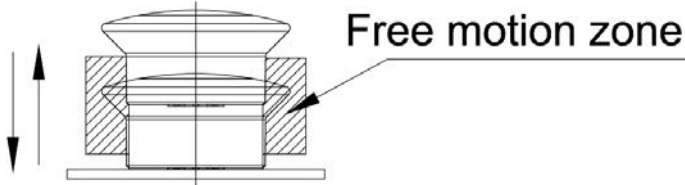

Ensure that this actuator will operate fully after installation. Failure to follow these will result in death or serious injury.

### Mounting

: Fixing Centers: 40mm X 30mm Min.  
Mounting Panel thickness: 1mm to 6mm

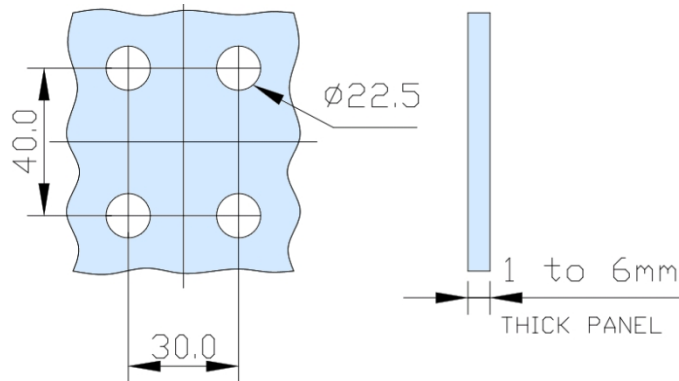

### No of elements possible

6 Nos. Max. Contact blocks can be mounted. (2\*3 Nos.) (FMR C... series contact elements)

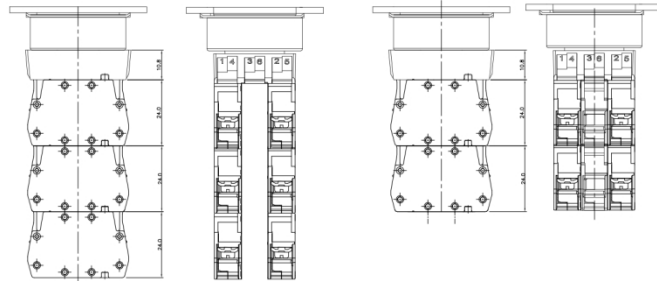

### To install:

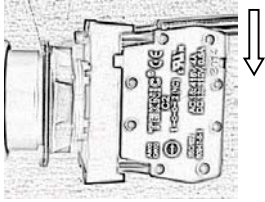

Insert screw driver in the bracket slot & twist the screw driver. The assembly separates out.

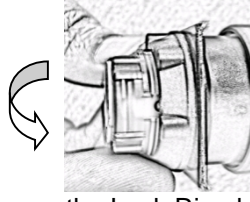

Remove the Lock Ring by turning anticlockwise.

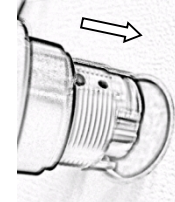

Insert the assembly in Ø22.5 hole. Ensure belt ring is there as it provide IP65 protection to the assembly.



Assemble the Lock Ring by turning it clockwise with 2Nm torque.

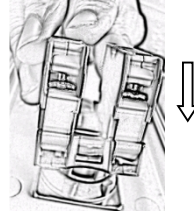

Assemble the contact element to the actuator by pushing it till a click sound comes.

Operate it for few times. The assembly is ready for use.

### To uninstall:

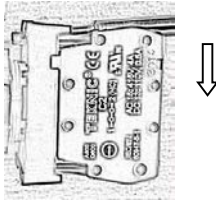

Insert screw driver in the bracket slot & twist the screw driver. The assembly separates out.



Remove the bracket & element assembly.

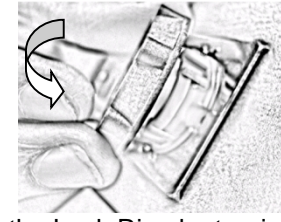

Remove the Lock Ring by turning it in anti clockwise direction

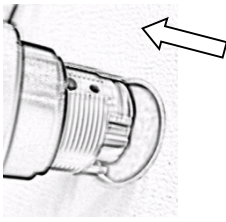

Remove the assembly.

Images are for representation only. Actual product may vary. If any more information is required, kindly contact our Marketing Department at +91-22-42532500 or email at [ram.talreja@teknico.in](mailto:ram.talreja@teknico.in)

Teknic Electric India Pvt Ltd may incorporate modification or improvements on its products at any time without notice, & therefore, in such events it is possible that the relevant part of this Data Sheet does not apply to your product.