

Model No.: **3PLBR348LH2C2-5VDC**
 Description: **Ø22.5 Monoblock series Battery Indicator**



Salient Features:

- Quick installation
- Safe operation
- Robust design
- Aesthetically elegant
- Works on 5VDC supply

General Characteristics:

It is a panel mounting LED monoblock circular pilot light available with DIN type connector & is simple to fit in a round cutout of Ø22.5 panel of thickness 1mm to 6mm. Fixing distance is 30mmX 40mm.



The pilot light can be fastened to the panel with the lock ring provided. To release the pilot light just unscrew the lock ring.

Available types	: 3PLBR348LH1C1-5VDC 3PLBR348LH2C1-5VDC 3PLBR348LH1C2-5VDC Where LH1 & LH2 indicate type of label C1 indicates AMP type of connector & C2 indicates DIN type connector
Degree of protection	IP65 as per IEC 60529
Degree of Pollution	: 3
Applicable standards	IEC 60947-5-1
Product Certification	CE

Mechanical Characteristics:

Function indicator		: Label indicating color & percentage of charge
Terminal Capacity		: NA
Terminal marking		:
Terminal Torque	Nm	: NA
Contact material		: Contact: Brass (tin plated)
Operation		: NA
Operating torque	Nm	: NA
Operating force	N	: NA
Positive operation		: NA
Conforming to IEC/EN 60947-5-1 Appendix K		
Operating travel	mm	: NA
Mechanical life		: NA
Ambient	°C	: -25 to +70
Storage	°C	: -25 to +40
Overall Dimensions with sketch (LXBXH)	mm	<p>103 series belt ring Ø28.5X0.8thk (ID=Ø22.0)</p>
Vibration resistance Conforming to IEC 60068-2-6	Hz	: NA
Shock resistance Conforming to IEC 60068-2-27		: NA
Viewing Angle	°	: NA
Optical Axial intensity	mcd	: NA
Weight	gms	:

Electrical Characteristics of contacts:

Make & Break Capacity		: Rated 5VDC
Rated insulation voltage	V	: 500
Rated thermal current	A	: NA
Low power application		: NA
Short circuit protection		: NA
Dielectric Test	KV	: 2.5
Approvals regarding the part:		: CE
Approvals regarding the material		
Polymeric parts		: UL-Recognized material
Rated Impulse Withstand		:
Polarity protection		:
Current Consumption	mA	Max. 200mA for DC circuits
Electrical Endurance		: 100000hours

Accessories & codes:

Spanner P2/P6SPNR



Ordering codes

The ordering code for each product is mentioned in the Catalogue/Data Sheet and not indicated on each product because of the various combinations possible it becomes practically impossible to do so, more over the actuators, lamp unit and contact element, which together make a push button, are sold separately to OEM's as well as dealers. However the primary packing box always mentions the ordering code of the material it holds.

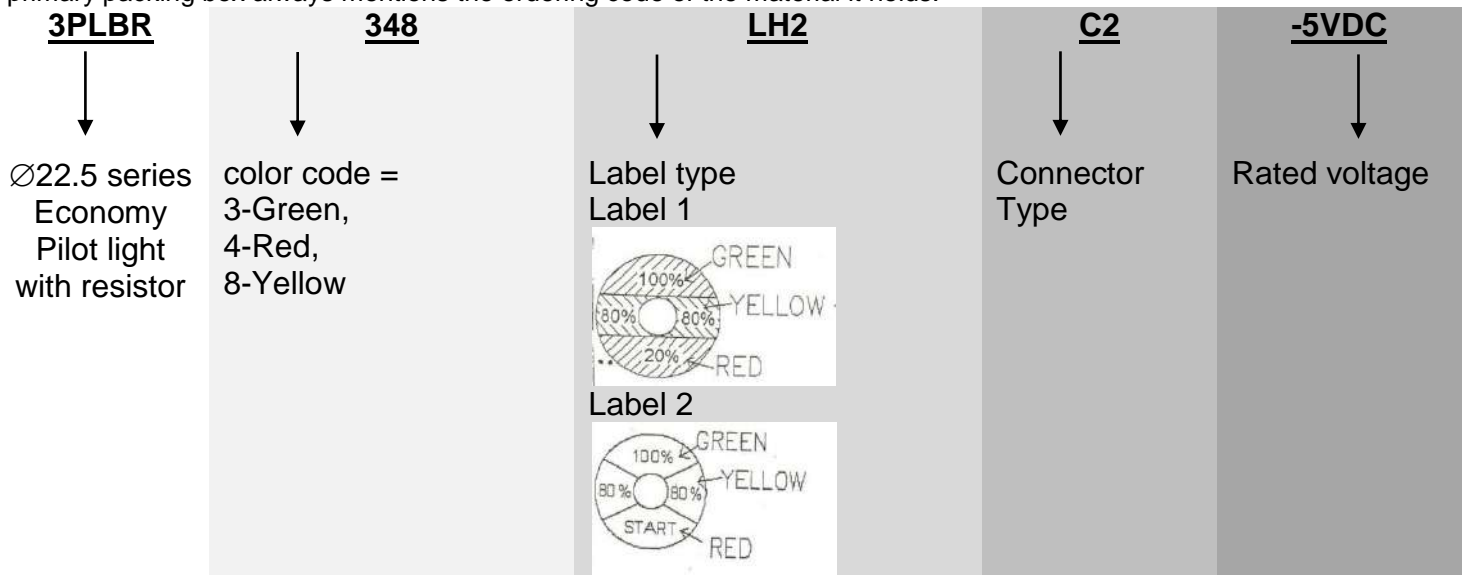

Mounting Instructions:

Safety regulations: This unit may be installed & commissioned by personnel who are familiar with current regulation for health & safety at work & accident prevention. Ensure local regulations are met especially those relating to safety. This is for use on flat surface of type 4X, 12 enclosure.

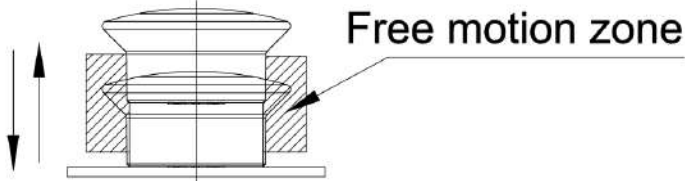

Ensure that this actuator will operate fully after installation. Failure to follow these will result in death or serious injury.

Mounting

: Fixing Centers: 40mm X 30mm Min.
Mounting Panel thickness: 1mm to 6mm

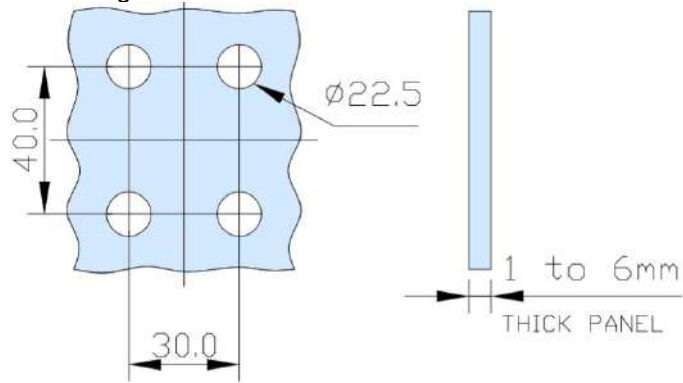

No of elements possible

: NA

To install:



Remove the Lock Ring by turning anticlockwise.

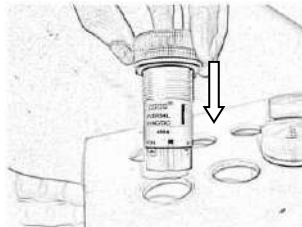

Insert the assembly in Ø22.5 hole. Ensure belt ring is there.

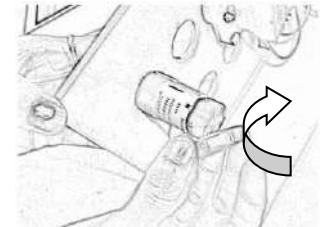

Assemble the Lock Ring by turning it clockwise with 2Nm torque. Use recommended Spanner P2SPNR.

To uninstall:

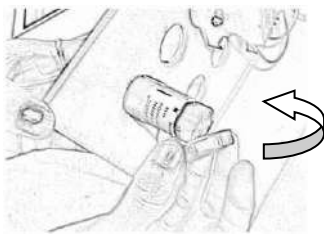

Remove the wires. Disassemble the Lock Ring by turning it anticlockwise. Use recommended Spanner P2SPNR

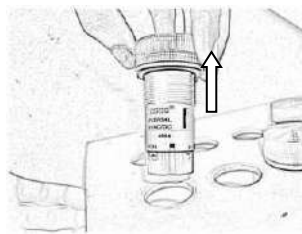

Remove the assembly

If any difficulty or malfunctioning is observed, kindly contact our Marketing Department at +91-22-42532500 or email at ram.talreja@teknico.in