

Model No.: **2BRKXXYY-EN-A-LLL**  
 Description: **Ø22.5 Series Encapsulated Contact Block**



### Salient Features:

- Quick installation
- Safe operation
- Robust design
- IP68 protection
- High pressure cleaning (front & back water proof)
- Shock resistance reinforced
- Salt, hydrocarbon & cleaning agent resistant
- Contact block & cable over molded
- Provided with 0.5mm<sup>2</sup> 4 core wire with customer specified cable length

### General Characteristics:

It's a rubberized encapsulated assembly consisting of a coated metal bracket Model 2BRK with two S series contact elements (Regular or Gold version) with cable connected. Its molded out of low pressure molding encapsulated or EPDM or TPE. It is provided with 0.5mm<sup>2</sup> 4 core wire. Yellow Green wires are for NO connections & White brown wires are for NC connections. Special connectors are available on request. The marking is provided on the terminal wires & the boot.

This IP68 protected Contact block can be used with our below non illuminated actuators:

Description of Actuator Head	Model Number	Remarks
Flush Booted	2AFBX	Where X is color of actuator button*
Mushroom headed Ø40	2AMPPXBX	Where first X is color of knob second X color of bellow (red is standard)*
Mushroom headed Jumbo Ø60	2AMJPPXBX	Where first X is color of knob second X color of bellow (red is standard)*
Mushroom headed Jumbo Ø70	2AMJPPXBXD7	Where first X is color of knob second X color of bellow (red is standard)*
Double Headed (with boot with boot 2ATBT7)	2ATFXFX	Where X is color of actuator button*
Flush (with boot 2BT7)	2AFX	Where X is color of actuator button*

\*Color code X→1=White, 2=Black, 3=Green, 4=Red, 6=Blue, 8=Yellow

\*Color availability & Technical details on request

A minimum of one contact element & a maximum of two contact elements can be made available in this assembly. Option of stacking maximum four elements is available on request. The actuator is bayonet locking into the bracket. Two lock screws are provided with the bracket. After assembly, the lock screws are to be equally tightened with a torque of 1.2Nm so that they pierce through the paint of the panel. This will ensure good earthing to the unit. This actuator can be used with any panel, ranging from 1mm to 6mm thickness.

Back sealed connector & desired cable length can be offered as per request.

Available types		: Refer Annexure A
Degree of protection		: IP68 as per IEC 60529 : Environment 60068
Degree of Pollution		: 3
Applicable standards		Concept: UL508, IEC 60947-5-1, 60947-5-5, CSA 22.2 Application: EN50155 EMC 50121-1-2-3 Fire/Smoke: NFF 16 101 102 Shocks Vibration: EN 61373
Product Certification		

### Mechanical Characteristics:

Function indicator			: Marking provided on rubber boot
Terminal Capacity			: NA
Terminal marking			: Markings provided on wiring terminal
Terminal Torque		Nm	: NA
Contact material	contact element		: Brass terminal, Silver plated
Operation	contact element		: Slow make/break
Operating torque		Nm	: NA
Operating force		N	: 17 (with Flush actuator) : 29 (With Mushroom actuator)
Positive operation Conforming to IEC/EN 60947-5-1 Appendix K			: All functions incorporating a NC contact are positive opening operation
Operating travel	contact element	mm	: 5

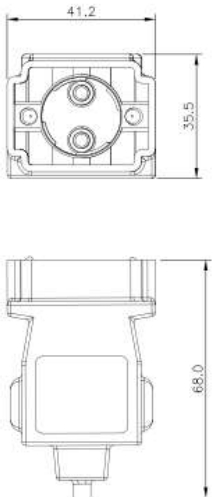
Mechanical life	contact element		: over 2 million operations
Ambient		°C	: -30 to +70
Storage		°C	: -30 to +40
Overall Dimensions with sketch (LXBXH)		mm	
Vibration resistance Conforming to IEC 60068-2-6		Hz	: Pending
Shock resistance Conforming to IEC 60068-2-27			: Pending
Viewing Angle		°	: NA
Optical Axial intensity		mcd	: NA
Weight		gms	: 140

### Electrical Characteristics of contacts:

Make & Break Capacity		AC15: 415VAC, 4A DC13: 0.5A, 110VDC As per CSA C22.2 no. 14-05, UL 508: A600, Q600																								
	V	<table border="0"> <tr> <td>AC15</td> <td></td> <td></td> <td></td> </tr> <tr> <td>V</td> <td>24</td> <td>120</td> <td>230</td> </tr> <tr> <td>A</td> <td>4</td> <td>3</td> <td>2</td> </tr> <tr> <td>DC13</td> <td></td> <td></td> <td></td> </tr> <tr> <td>V</td> <td>24</td> <td>110</td> <td></td> </tr> <tr> <td>A</td> <td>0.5</td> <td>0.2</td> <td></td> </tr> </table>	AC15				V	24	120	230	A	4	3	2	DC13				V	24	110		A	0.5	0.2	
AC15																										
V	24	120	230																							
A	4	3	2																							
DC13																										
V	24	110																								
A	0.5	0.2																								
Rated insulation voltage		: 500																								
Rated thermal current	A	: 10																								
Low power application		: NA																								
Short circuit protection		: 10A HRC cartridge fuse, rated for resistive loading																								
Dielectric Test	KV	: 2.5																								
Approvals regarding the part:		: 																								
Approvals regarding the material																										
Polymeric parts		: UL-Recognized material																								
Rated Impulse Withstand		: NA																								
Polarity protection		: NA																								
Current Consumption	mA	: NA																								
Electrical Endurance		: Conforming to IEC/EN 60947-5-1 Annexure C																								

### Accessories & codes:

NA

### Ordering codes

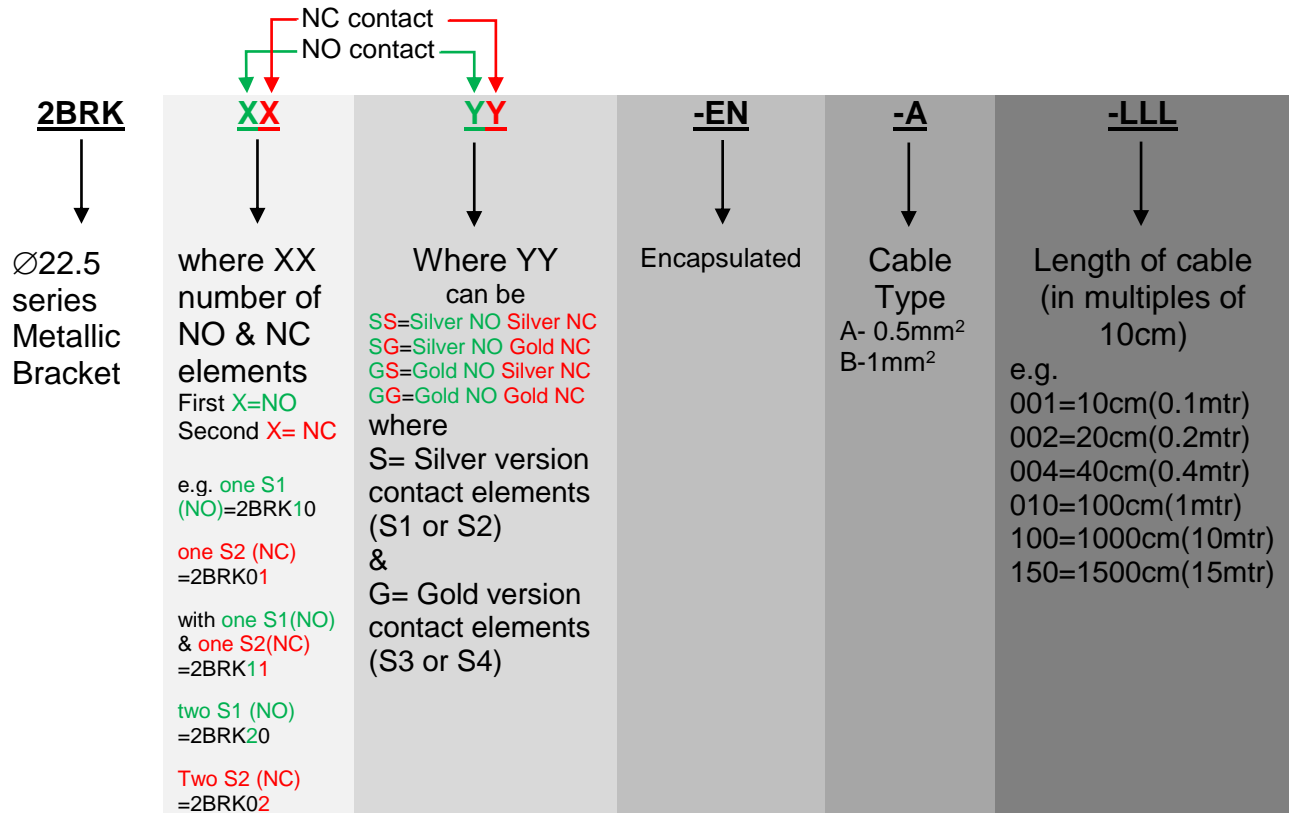

Complete model number	Complete Description
2BRK1OSS-EN-A-002	Encapsulated Bracket with one S1 (NO), 0.5mm <sup>2</sup> wire,200mm
2BRK01SS-EN-A-002	Encapsulated Bracket with one S2 (NC), 0.5mm <sup>2</sup> wire,200mm
2BRK2OSS-EN-A-002	Encapsulated Bracket with two S1 (NO), 0.5mm <sup>2</sup> wire,200mm
2BRK02SS-EN-A-002	Encapsulated Bracket with two S2 (NC), 0.5mm <sup>2</sup> wire,200mm
2BRK11SS-EN-A-002	Encapsulated Bracket with one S1 (NO) one S2 (NC), 0.5mm <sup>2</sup> wire,200mm
2BRK1OGG-EN-A-002	Encapsulated Bracket with one S3 (NO) gold, 0.5mm <sup>2</sup> wire,200mm
2BRK01SG-EN-A-002	Encapsulated Bracket with one S4 (NC) gold, 0.5mm <sup>2</sup> wire,200mm
2BRK2OGS-EN-A-002	Encapsulated Bracket with two S3 (NO) gold, 0.5mm <sup>2</sup> wire,200mm
2BRK02SG-EN-A-004	Encapsulated Bracket with two S4 (NC) gold, 0.5mm <sup>2</sup> wire,400mm
2BRK11GG-EN-A-002	Encapsulated Bracket with one S3 (NO) one S4 (NC) gold, 0.5mm <sup>2</sup> wire,200mm
2BRK11GS-EN-A-002	Encapsulated Bracket with one S3 (NO) one S2 (NC), 0.5mm <sup>2</sup> wire,200mm
2BRK11SG-EN-A-002	Encapsulated Bracket with one S1 (NO) one S4 (NC), 0.5mm <sup>2</sup> wire,200mm
2BRK02SG-EN-A-002	Encapsulated Bracket with two S4 (NC) gold, 0.5mm <sup>2</sup> wire,200mm

### Mounting Instructions:

**Safety regulations:** This unit may be installed & commissioned by personnel who are familiar with current regulation for health & safety at work & accident prevention. Ensure local regulations are met especially those relating to safety. This is for use on flat surface of type 4X, 12 enclosure.

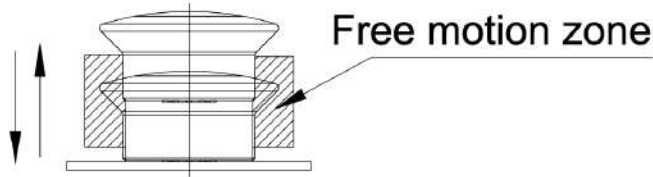

Ensure that this actuator will operate fully after installation. Failure to follow these will result in death or serious injury.

Mounting

: Fixing Centers: 45mm X 40mm Min.

Mounting Panel thickness: 1mm to 6mm

No of elements possible

: 2X2 Nos elements max

### To install

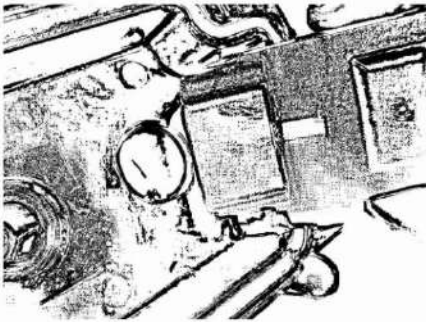

REAR SIDE

Align the bracket assembly with the 22.5 cutout from the rear side of the panel

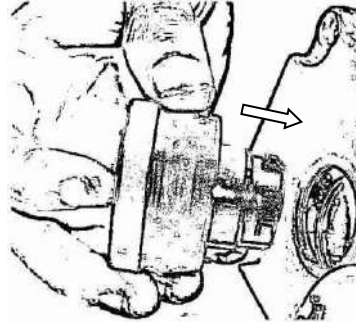

FRONT SIDE

Insert the Actuator into the 22.5 cutout

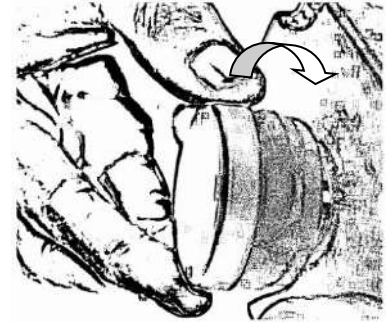

Turn it in clockwise direction to lock it

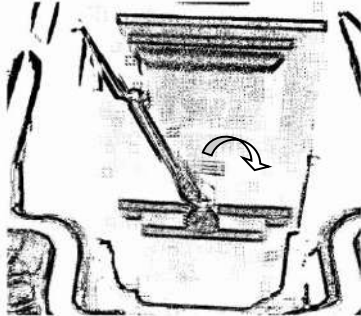

Tighten the lock screw equally with a torque of 1.2Nm

### To uninstall

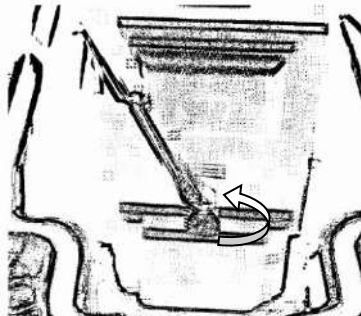

Unscrew the lock screw by turning it in anticlockwise direction

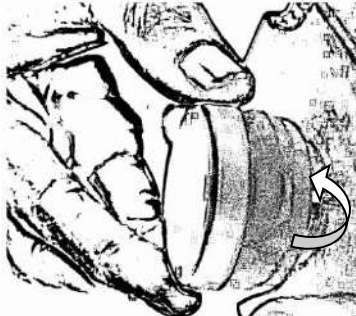

Turn the actuator in anticlockwise direction

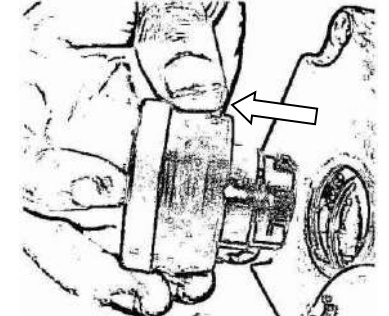

Remove the actuator by pulling it out

For any more information required, kindly contact our Marketing Department at +91-22-42532500 or email at [ram.talreja@teknico.in](mailto:ram.talreja@teknico.in)